



40 GHz SMA-2.9 LATCHING S.P.D.T. SWITCH

OPTIONS : INDICATOR / TTL DRIVE

R F CHARACTERISTICS

FREQUENCY RANGE : 0 - 40 GHz
 IMPEDANCE : 50 Ohms

FREQUENCY (GHz)	0 - 6	6 -12.4	12.4- 18	18 -26.5	26.5- 40
V.S.W.R <=	1.30	1.40	1.50	1.70	1.90
INSERT. LOSS <=	0.30 dB	0.40 dB	0.50 dB	0.70 dB	0.80 dB
ISOLATION >=	70 dB	60 dB	60 dB	55 dB	50 dB
AVER. POWER (*)	80 W	60 W	50 W	20 W	10 W

ELECTRICAL CHARACTERISTICS

ACTUATOR : LATCHING
 NOMINAL CURRENT AT 25° C (±10%) : 210 mA
 ACTUATOR VOLTAGE (Vcc) : 12V (10.2 to 13V)/ NEGATIVE COMMON
 TERMINALS : solder pins (250° C max./30 sec.)
 INDICATOR RATING : 1 W / 30 V / 100 mA
 TTL INPUTS (E) - High level : 2.2 to 5.5V / 800µA at 5V
 - Low level : 0 to 0.8V / 20µA at 0.8V

MECHANICAL CHARACTERISTICS

CONNECTORS : SMA 2.9fem. per MIL C 39012
 LIFE : 10.000.000 cycles
 SWITCHING TIME (nominal voltage;25° C) : < 10 ms
 CONSTRUCTION : splashproof
 WEIGHT : < 45 g

ENVIRONMENTAL CHARACTERISTICS

OPERATING TEMPERATURE RANGE (°C) : -40 , +85
 STORAGE TEMPERATURE RANGE (°C) : -55 , +85

(* : average power at 25° C)

This information is given as an indication. In the continual goal to improve our products, we reserve the right to make any modifications judged necessary

4112-9212

DRAWING

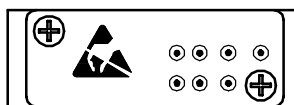
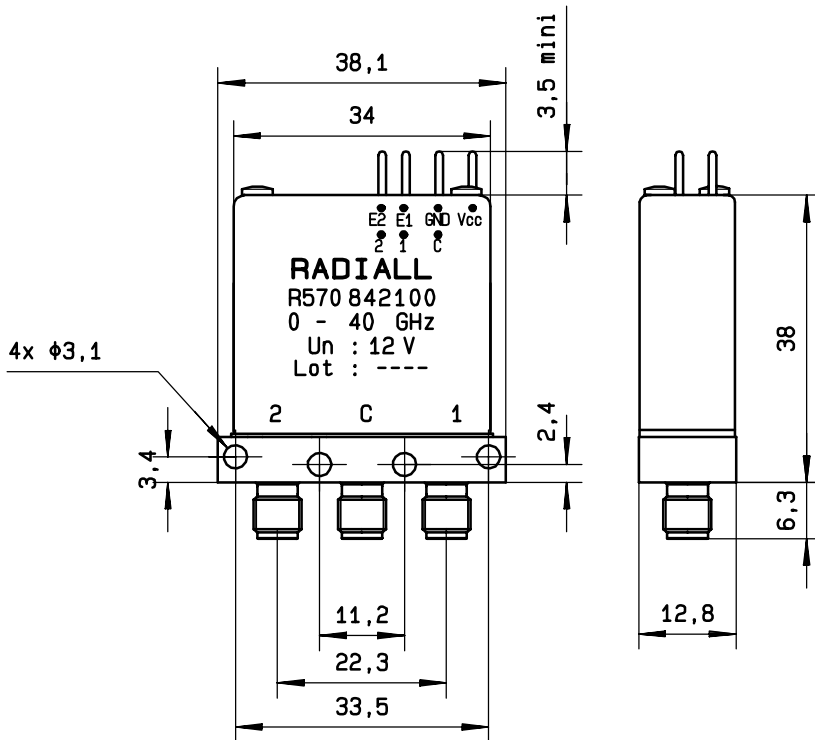

General tolerance: $\pm 0,5$ mm

SCHEMATIC DIAGRAM

TTL input	RF continuity	Indicator
E1=1 E2=0	C \leftrightarrow 1	C . 1
E1=0 E2=1	C \leftrightarrow 2	C . 2
E1=0 E2=0	Memory	—
E1=1 E2=1	Forbidden	—

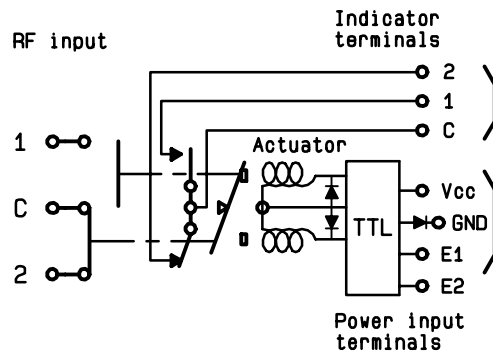

4113-9212 This information is given as an indication. In the continual goal to improve our products, we reserve the right to make any modifications judged necessary